

# ONKYO

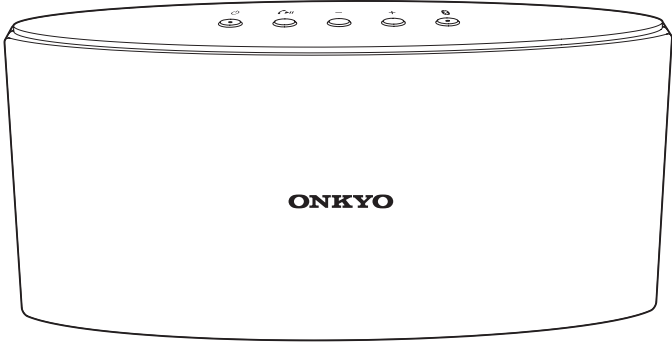

X3

USER  
MANUAL



# Contents

---

<b>1 Important</b>	2
--------------------	---

---

<b>2 Your Bluetooth speaker</b>	3
Introduction	3
What's in the box	3
Overview of the speaker	4

---

<b>3 Get started</b>	5
Power supply	5
Switch on or go to standby mode	5

---

<b>4 Use Bluetooth devices</b>	7
Connect a Bluetooth-enabled device	7
Play from a Bluetooth-enabled device	8
Control your phone call	8

---

<b>5 Other features</b>	9
Listen to an external device	9
Charge your mobile device	9
Adjust volume	9

---

<b>6 Product information</b>	10
Specifications	10

---

<b>7 Troubleshooting</b>	11
General	11

---

<b>8 Notice</b>	12
-----------------	----

# 1 Important



## Warning

- Never remove the casing of this speaker.
  - Never lubricate any part of this speaker.
  - Never place this speaker on other electrical equipment.
  - Keep this speaker away from direct sunlight, naked flames or heat.
- 
- Make sure that there is enough free space around the device for ventilation.
  - Use only power supplies listed in the user manual.
  - Only use attachments or accessories specified by the manufacturer.
  - The battery shall not be exposed to excessive heat such as sunshine, fire or the like.
  - The device shall not be exposed to dripping or splashing.
  - Do not place any sources of danger on the device (e.g. liquid filled objects, lighted candles).
  - Where the plug of the Direct Plug-in Adapter is used as the disconnect device, the disconnect device shall remain readily operable.



## Note

- The type plate is located on the bottom of the product.

### About operating temperatures and humidity

- Operate in a place where temperature is between 0°C (32°F) and 40°C (104°F) (up to 80% relative humidity)
- Battery life may be shorter in high or low temperature conditions

# 2 Your Bluetooth speaker

Thank you for purchasing an Onkyo product. Please read this manual carefully before making any connections or using this product. By following these instructions, you'll get the best audio performance and the most listening pleasure from your Onkyo product. Keep this manual for future reference.

---

## Introduction

With this speaker, you can

- enjoy audio from your Bluetooth-enabled devices or other external audio devices;
- control the incoming phone call through Bluetooth connection; and
- charge your mobile devices through the USB cable.

---

## What's in the box

Check and identify the contents of your package:

- Main unit
- Power adapter
- 3.5mm audio cable
- USB cable
- Printed materials

---

## Overview of the speaker

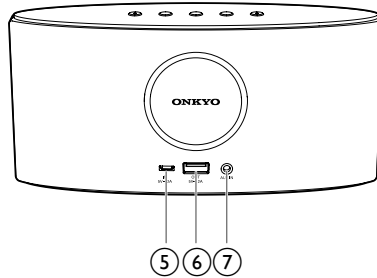
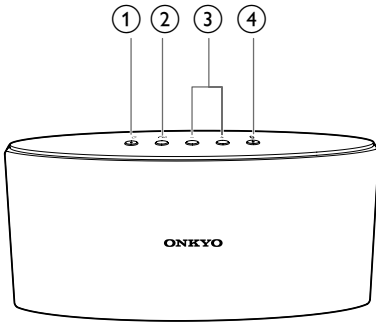

### ① **⏻ button/indicator**

- Press briefly to switch on or go to standby mode.
- In standby mode, press and hold to switch off.
- Indicate the power status.

### ② **⏮⏭ button/indicator**

- Start, pause, or resume play.
- Press to answer an incoming call.
- Press and hold to reject an incoming call.
- During a call, press to end the current call.

### ③ **-/+ button/indicator**

- Adjust volume.

### ④ **📶 button/indicator**

- Press and hold for 2 seconds to enter pairing mode manually.
- Press and hold for 7 seconds to clear pairing information.
- Indicate the Bluetooth connection status.

### ⑤ **Micro USB socket for power supply**

- Charge the built-in battery of the speaker.

### ⑥ **USB charging socket**

- Charge an external mobile device.

### ⑦ **AUDIO IN socket**

- Connect an external audio device.

# 3 Get started

Always follow the instructions in this chapter in sequence.

## Power supply

Either AC power or battery can be used as power supply of this product.

### Option 1: AC power

#### ! Caution

- Risk of product damage! Make sure that the power voltage corresponds to the voltage printed on the back or underside of the speaker.
- Risk of electric shock! When you unplug the AC adapter, always pull the plug from the socket. Never pull the cord.

- Connect the power adaptor to:
  - the **DC IN** socket at the back of the speaker.
  - the wall outlet.

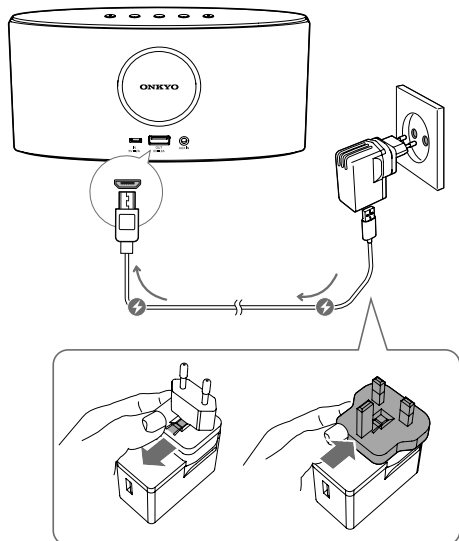

### Option 2: Battery power

The speaker can also be powered by the built-in rechargeable battery.

#### ≡ Note

- Rechargeable battery has a limited number of charge cycles. The battery life and number of charge cycles vary by use and settings.
- It takes you approximately three hours to fully charge the battery.

### To charge the built-in battery:

- Connect to AC power supply.

System status	Battery status	Power LED status
On/off	Low power (less than 10%)	Flashing red
On	Under charging	Flashing white
On	Fully charged	Solid white

## Switch on or go to standby mode

- Press  $\odot$  to switch the speaker on.
  - ↳ If the speaker is fully charged, the power indicator turns solid white.
  - ↳ If the speaker is being charged, the power indicator flashes white.
  - ↳ If the speaker is in low battery (with less than 10% power), the power indicator flashes red.
- To enter standby mode, press  $\odot$  briefly.
  - ↳ The power indicator is dimmed in white.
- To switch off when the speaker is on or in standby mode, press and hold  $\odot$  for two seconds.
  - ↳ The power indicator turns off.



#### Tip

- In Bluetooth mode, if Bluetooth connection is invalid or music playback is stopped for 15 minutes, this speaker switches to standby mode automatically.
- In AUX IN mode, if the audio-in cable is disconnected or music playback is stopped for 15 minutes, this speaker switches to standby mode automatically.



## 4 Use Bluetooth devices

With this speaker, you can listen to audio from Bluetooth-enabled devices and control the incoming call through Bluetooth.

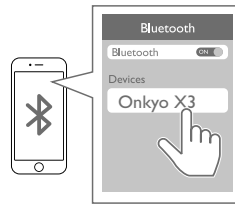
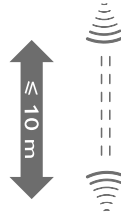
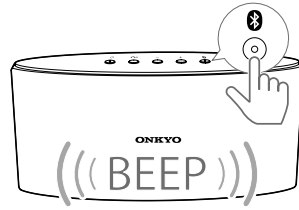

### Connect a Bluetooth-enabled device

#### Note

- Make sure that your Bluetooth device is compatible with this speaker.
- Before pairing a device with this speaker, read its user manual for Bluetooth compatibility.
- The speaker can memorize a maximum of two paired devices.
- Make sure that Bluetooth function is enabled on your device, and your device is set as visible to all other Bluetooth devices.
- Any obstacle between this speaker and a Bluetooth device can reduce the operational range.
- Keep away from any other electronic device that may cause interference.
- The operational range between this speaker and a Bluetooth device is approximately 10 meters (30 feet).

The speaker can connect up to 2 Bluetooth-enabled devices at the same time.

- 1** Press and hold  on the speaker for two seconds.
  - ↳ The Bluetooth indicator flashes blue.
- 2** On your Bluetooth device, enable Bluetooth and search for Bluetooth devices (refer to the user manual of the device).
- 3** When **[Onkyo X3]** is displayed on your device, select it to start pairing and connection. If necessary, enter the default password "0000".
  - ↳ After successful pairing and connection, the speaker beeps twice, and the Bluetooth indicator turns solid blue.
- 4** Repeat steps 1 to 3 to add a second Bluetooth device.

### Note

- When there are two Bluetooth-enabled devices connected to the speaker, you can repeat steps 1 to 3 to add a new device. In this case, the earliest connected device will be replaced.

### To disconnect the Bluetooth-enabled device:

- Disable Bluetooth on your device; or
- Move the device beyond the communication range.

### To clear the existing pairing information:

- Press and hold **0** for 7 seconds.

### To reconnect the Bluetooth-enabled device:

- For a paired Bluetooth device on which automatic reconnection is enabled, this product reconnects with it once it is detected.
- For a paired Bluetooth device that does not support automatic reconnection, reconnect it with this product manually.

Bluetooth indicator	Description
Flashing blue	Connecting or waiting for connection
Solid blue	Connected

## Play from a Bluetooth-enabled device

### Note



- If there is an incoming call on the connected mobile phone, music play pauses.
- After successful Bluetooth connection, play music on a connected Bluetooth device.
  - ↳ Music streams from your Bluetooth device to the speaker.

### Note

- To play from another connected device, just use controls on that device directly and the music streaming from the current device will be paused.

## Control your phone call

After Bluetooth connection, you can control an incoming call with this speaker.

Button	Function
	Press to answer an incoming call.
	Press and hold to reject an incoming call.
	During a call, press to end the current phone call.

### Note

- You can talk through the microphone of the speaker.
- Music play pauses when there is an incoming call, and resumes when your phone call ends.

## 5 Other features

### Listen to an external device

With this speaker, you can also listen to an external audio device such as an MP3 player.

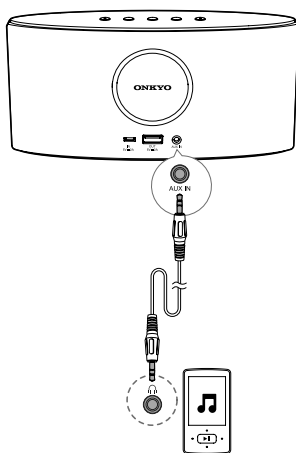

- 1 Make sure there is no music streaming from the connected Bluetooth device (if available).
- 2 Connect an audio input cable with a 3.5 mm connector on both ends to
  - the **AUX IN** socket on this speaker, and
  - the headphone socket on the external device.
- 3 Play music on the external device (refer to its user manual).
  - ↳ The speaker switches to the AUX IN source.

#### Tip

- When you start music streaming from a connected Bluetooth device, the speaker switches to the Bluetooth source automatically.

### Charge your mobile device

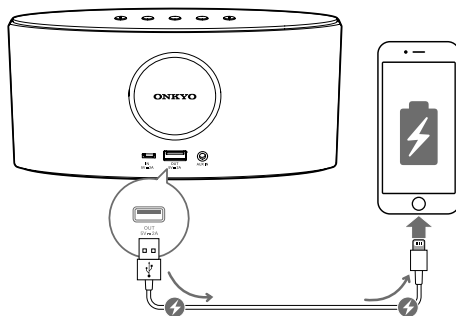

- 1 Connect a USB charging cable to
  - the USB output socket on this speaker, and
  - the USB input socket on the external device.
- 2 Check that the speaker is switched on or in standby mode.

### Adjust volume

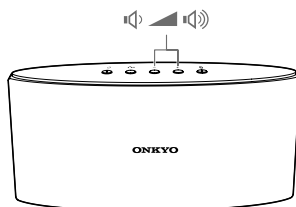

- Press **+/-** on the speaker to increase or decrease the volume.

# 6 Product information



## Note

- Product information is subject to change without prior notice.

Built-in Battery	Lithium ion battery (7.4 V, 3400 mAh)
Dimensions - Main Unit (W x H x D)	195 x 93 x 51 mm
Weight - Main Unit	0.6 kg

## Specifications

### Amplifier

Rated Output Power	2 x 4.5W, 1% THD
Frequency Response	40 Hz - 20 kHz, $\pm 3$ dB
Signal to Noise Ratio	> 80 dBA
Aux In	650mV (RMS), 22k ohm

### Bluetooth

Bluetooth version	V2.1
Supported Profiles	HFP, A2DP, AVRCP
Range	10 m (Free space)

### Speakers

Speaker Impedance	4 ohm
Speaker Driver	2 x 1.75" full range drivers
Sensitivity	> 82dB/m/W $\pm$ 3dB/m/W

### General information

Power Adaptor	AS340-100-AD270
Power Input	100 - 230V, 50/60 Hz
DC Output	5V, 2A
USB Charging Output	DC5V, 2A

# 7 Troubleshooting



## Warning

- Never remove the casing of this device.

To keep the warranty valid, never try to repair the system yourself.

If you encounter problems when using this device, check the following points before requesting service. If the problem remains unsolved, contact Onkyo service center. When you contact Onkyo, make sure that the device is nearby and the model number and serial number are available.

---

## General

### No power

- Make sure that the AC power plug is connected properly.
- Make sure that there is power at the AC outlet.
- Recharge the built-in battery.

### No sound

- Adjust volume on the speaker or the Bluetooth-connected device.
- Make sure that your Bluetooth device is within the effective operational range.

### No response from the speaker

- Restart the speaker.

---

## About Bluetooth device

### The audio quality is poor after connection with a Bluetooth-enabled device.

- The Bluetooth reception is poor. Move the device closer to this speaker or remove any obstacle between them.

### Cannot connect with the device.

- The Bluetooth function of the device is not enabled. Refer to the user manual of the device for how to enable the function.
- The speaker is not in pairing mode. Hold **Ⓟ** to enter pairing mode, and then try again.

### The paired device connects and disconnects constantly.

- The Bluetooth reception is poor. Move the device closer to this product or remove any obstacle between them.
- For some devices, Bluetooth connection may be deactivated automatically as a power-saving feature. This does not indicate any malfunction of this speaker.

### The speaker is in demo mode and not working as usual.

- The demo mode is not intended for end users. You may have activated this mode by accident. In this case, press and hold **Ⓟ** for 15 seconds to exit demo mode and enter standby mode. Then you can power on and operate the speaker as usual.

# 8 Notice

## CE 0560

Hereby, Gibson Innovations declares that this product is in compliance with the essential requirements and other relevant provisions of Directive 1999/5/EC. You can contact Onkyo service center to get the Declaration of Conformity.

Any changes or modifications made to this device that are not expressly approved by Gibson Innovations may void the user's authority to operate the equipment.

### Disposal of your old product and battery



Your product is designed and manufactured with high quality materials and components, which can be recycled and reused.



This symbol on a product means that the product is covered by European Directive 2012/19/EU.



This symbol means that the product contains a built-in rechargeable battery covered by European Directive 2013/56/EU which cannot be disposed of with normal household waste. We strongly advise you to take your product to an official collection point or an Onkyo service centre to have a professional remove the rechargeable battery.

Inform yourself about the local separate collection system for electrical and

electronic products and rechargeable batteries. Follow local rules and never dispose of the product and rechargeable batteries with normal household waste. Correct disposal of old products and rechargeable batteries helps prevent negative consequences for the environment and human health.



### Caution

- Removal of the built-in battery invalidates the warranty and may destroy the product.

Always bring your product to a professional to remove the built-in battery.

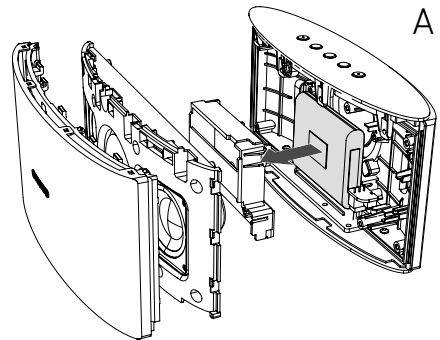

### Environmental information

All unnecessary packaging has been omitted. We have tried to make the packaging easy to separate into three materials: cardboard (box), polystyrene foam (buffer) and polyethylene (bags, protective foam sheet.)

Your system consists of materials which can be recycled and reused if disassembled by a specialized company. Please observe the local regulations regarding the disposal of packaging materials, exhausted batteries and old equipment.



The Bluetooth® word mark and logos are registered trademarks owned by Bluetooth

SIG, Inc. and any use of such marks by Gibson Innovations Limited is under license. Onkyo® is a registered trade mark of Onkyo Corporation. Other trademarks and trade names are those of their respective owners.

# ONKYO

[www.onkyo-speakers.com](http://www.onkyo-speakers.com)

Specifications are subject to change without notice.

2016 © Gibson Innovations Limited. All rights reserved.

This product has been manufactured by, and is sold under the responsibility of Gibson Innovations Ltd., and Gibson Innovations Ltd. is the warrantor in relation to this product.

Onkyo® is a registered trade mark of Onkyo Corporation. Other trademarks and trade names are those of their respective owners.

OKAX3\_10\_UM\_V4.0

**C E 0560**

**EAC**

